

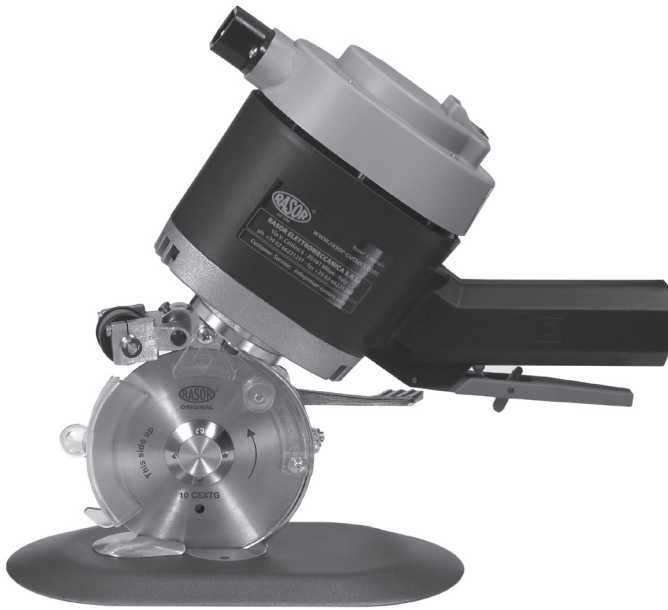

1946

# D100

BENCH CUTTER



# USE MANUAL

Rasor® Elettromeccanica S.r.l. was established in Milan in 1946 by the two promoting partners Spinelli and Ciminaghi. For more than sixty years it has been producing automatic cutting systems, cutting units for textile applications and electric and pneumatic cutters.



Initially considered as a point of reference for cutting systems in the textile applications, the Rasor® products are nowadays widely used in other fields: chemical, automotive, nautical and sport sectors and in furniture manufacturing.

Rasor® can rely on the professional continuity of three generations, thanks to the precious support of the promoting partner, to his passion, dedication and great experience of seventy years.

The main characteristic of Rasor® is that each working phase, starting from the manufacturing of the product up to its packing and delivery is carried out in Rasor® premises by qualified operators who have professionally grown up following the spirit of the company and of its founders. This ensures the high quality which Rasor® has always considered as essential since the beginning of its activity.

Following the innovative spirit mentioned above, our company is constantly focused on the improvement of the product quality, on the study and development of new materials and technologies.

## ACKNOWLEDGMENT

Dear Customer,

thank you for choosing a Rasor® Elettromeccanica S.r.l. product.

Rasor® has been a reference point in the field of cutting systems in the textile, clothing, furniture, tailoring, sport, chemical, automotive, nautical and insulating material sectors for years. Its production has been always synonymous with reliability attested by many of satisfied customers.

Rasor® quality system supervises all the company activities in order to provide the Customer with a service that meets its needs and expectations in terms of product quality, delivery reliability and stock of finished products.

All the parts of the devices have been planned and produced to guarantee an optimum performance. In order to keep the high quality level and the long reliability of the Rasor® products, it is recommended to use only original spare parts and to contact the head office for any maintenance work.

## 1. GENERAL SAFETY RULES



This manual is an integral part of bench cutter D 100 and must be carefully read before using it since it gives important indications with regards to its safe installation, use and maintenance. Keep it with care.



Before using bench cutter D 100, read carefully the following general safety rules.

- **PACKAGING.**  
After taking off the packaging make sure that the bench cutter is intact. In case of doubt do not use it and contact an authorized service centre. Do not leave pieces of packaging (plastic bags, foam polystyrene, boxes, etc.) within the reach of children or disabled persons since they are potential sources of danger.
- **AVOID DANGEROUS ENVIRONMENTS.**  
Prevent the bench cutter D 100 components from coming in contact with damp or wet surfaces.
- **KEEP CHILDREN AWAY.**  
Unauthorized persons, in particular children, must be kept away from the working area.
- **FEED CABLE.**  
Prevent the feed cable from coming in contact with hot objects, pointed surfaces or sharp edges. Never pull the feed cable of the machine. It must never be replaced by the user. If necessary contact professionally qualified staff.
- **KEEP THE WORKING AREA ALWAYS IN ORDER.**  
The workplace must always be kept in order and well lightened; liquids or oil traces must not be present.
- **ALWAYS USE BENCH CUTTERS D 100 PROPERLY.**  
Use the bench cutters only to carry out the works they have been designed for; do not use them improperly.
- **OBSERVE THE USE OF THE TOOLS.**  
Do not cut excessively thick materials and always check blade conditions.
- **AVOID ACCIDENTAL STARTINGS.**  
Before connecting bench cutter D 100, make sure that everything is installed properly.
- **CLOTHING.**  
Do not use large clothes or accessories that might get stuck in the moving parts.
- **GOGGLES AND PROTECTIVE METAL MESH GLOVES.**  
Always use goggles, protective metal mesh gloves approved by Rasor® during use and maintenance operations (according to UNI EN 388:2004 standard).
- **SPARE PARTS.**  
During maintenance and replacement operations use only original spare parts. Blade maintenance must be only performed by Rasor® technicians.
- **INSTALLATION.**  
Any installation that is not in conformity with these specifications could jeopardize your safety and cancels the warranty.

## Informative letter

The installer and the maintenance man must know the content of this manual. Although the main features of the machine described in this manual are not subject to change, **Rasor® Elettromeccanica S.r.l.** reserves the right to modify the components, details and accessories it deems necessary to improve the machine or to meet manufacturing or commercial requirements at any time and without being obliged to update this manual immediately.



**WARNING**



### **ALL RIGHTS ARE RESERVED ACCORDING TO THE INTERNATIONAL COPYRIGHT CONVENTIONS,**

The reproduction of any part of this manual, in any form, is forbidden without the prior written authorization of Rasor® Elettromeccanica S.r.l.

The content of this guide can be modified without prior notice. Great care has been taken in collecting and checking the documentation contained in this manual to make it as complete and comprehensible as possible.

Nothing contained in this manual can be considered as a warranty, either expressed or implied - including, not in a restrictive way, the suitability warranty for any special purpose. Nothing contained in this manual can be interpreted as a modification or confirmation of the terms of any purchase contract.

Rasor® Elettromeccanica S.r.l. machines have not been conceived to work in areas at risk of explosions and at high risk of fire and they cannot cut wet or damp materials. Moreover, they cannot work in case of rain.

In case of damage or malfunction, table cutter D 100 must not be used until the Customer Care Technical Service has repaired them.

### **Customer Care Technical Service**



For any information, please contact  
RASOR®ELETTROMECCANICA S.r.l.  
Via V. Caldesi, 6; 20161, MILANO (MI) - ITALY  
Phone: +39.02.66221231; Fax: +39.02.66221293  
e-mail: [info@rasor-cutters.com](mailto:info@rasor-cutters.com)  
web: [www.rasor-cutters.com](http://www.rasor-cutters.com)

**WARNING**



The original configuration of the table cutter must not be changed at all. On receiving the machine make sure the supply corresponds to what has been ordered. In case of non-compliance immediately inform Rasor®. Also make sure the scissors have not been damaged during transport.



## 2. TRANSPORT AND PACKING

The bench cutter is delivered in a cardboard box, inside which there are various options. The code of the ordered product and its serial number are indicated outside the package (see picture 1). The following accessories are contained in a bag inside the package:

- 1) Circular blade;
- 2) Butterfly wrench for blade nut disassembly.
- 3) Shuko cable without plug;
- 5) Fuse;
- 6) Drift for blade disassembly.

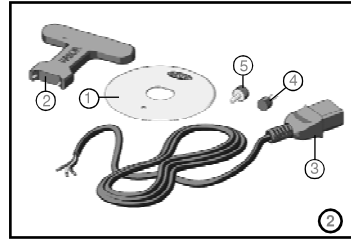
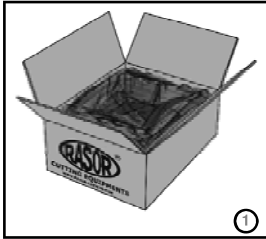

## 3. PLATE DATA

The manufacturer's identification and CE STANDARD 2006/42/CE conformity plate (see picture below) is located on the front part of the bench cutter.

The plate must not be removed at all, even if the machine is resold. Always refer to the serial number (written on the plate itself) when contacting the manufacturer.

Several safety warnings are printed on a card which is applied to the cutter feeding cable; such warnings must be strictly followed by everyone dealing with the machine. The company is not to be held responsible for damage to property or accidents to people which might occur if the above-mentioned warnings are not observed. In such a case, the operator is the only person responsible.

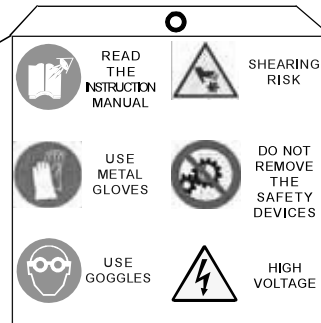
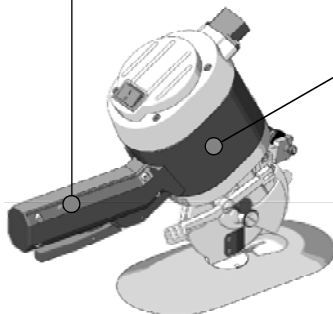
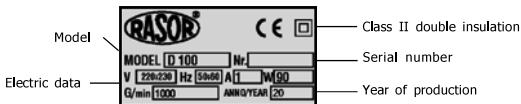

## 4. PRODUCT DESCRIPTION

The fixtures described in this manual is a bench cutter model D 100 which is used in order to quickly cut fabrics in the textile industry and other materials. It is extremely versatile and powerful, it requires little maintenance and has very low management costs. Thanks to the use of two stones to sharpen the blade, a sliding foot and an effective cutting system with circular blade, the bench cutter can cut different materials, such as natural fibers, cotton, linen, silk and woollen yarn.

The small dimensions of the blade (100 mm) and the light weight (only 3000 g) of the cutter, make it ideally suited for small radius cut profiles on materials with thickness up to 3,5 cm. The wide sliding bearing base allows the operator to slide the cutter on the table without efforts. A sharpener assembled on the cutter heads allows whetting the blade at any moment without disassembling it. After carrying out this operation, it is possible to start cutting again. A high power motor, perfectly balanced, with a high number of revolutions and totally free of maintenance, reduces the vibrations to the minimum, thus making the bench cutter complies with Legislative Decree No. 187 dated 19/8/2005, which adopts European Directive No. 2002/44/CE concerning the risks deriving from mechanical vibrations. The mechanical parts are made of high resistance steel and bronze and require lubrication after several working hours.

Device components

1	Switch provided with light	10	Plate blocking the threads
2	Motor cover	11	Greaser
3	Connector socket	12	Sharpener driving lever
4	Motor frame	13	Fixed back protection
5	Sharpener	14	Safety catch to enable the starting lever
6	Grinding wheel adjustment	15	Starting lever
7	Movable front protection	16	Handle
8	Roller platform covered with Teflon®	17	Sliding foot
9	Circular blade		

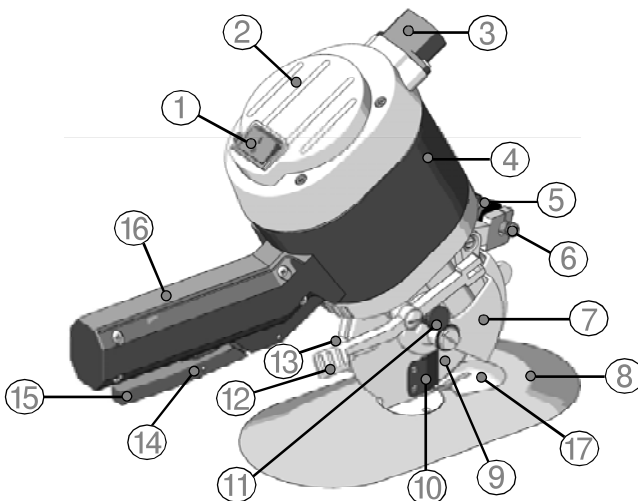

## 5. TECHNICAL FEATURES

Bench cutter D 100 features	
Blade diameter	100 mm
Blade speed	1.000 rev./min
Cutting working depth	about 35 mm
Motor power	monophase - 90 W
Absorption	1A
Weight (with feeding cable)	3,000 Kg
Weight with package	4,000 Kg
Electric cable length	1,5 mt
Minimum luminosity for working operations	LUX 200
Vibrations at the start up	< 2,5 m/s <sup>2</sup>
Temperature	0 ~ 55°C
Humidity	10 ~ 95% without condensate

Features of the available blades	
10CEXTG	Germany extra carbon steel circular blade
10CGHSS	HSS steel circular blade
10CEXTGTF	Extra carbon circular blade, covered with Teflon
10CGHSSSTN	HSS steel circular blade, covered with T.I.N.

The technical data are only indicative and they can be changed without notice.

## 6. RUMOR LEVEL

The maximum acoustic pressure level emitted by bench cutter D 100 is about 60 dB (A). Noise tests have been carried out in compliance with Standard ISO 11202 (1995). The device noise levels, measured at different distances (without any sound wave filtering system), vary in the extent of few db (A).

### NOTE

It is advisable for bench cutter D 100's owners to verify the compliance with the standard concerning safety of workers: Italian legislative decree N.277 ITEM IV (DATED 15-08-91). The use of ear protecting devices is compulsory.

## 7. FIELD OF APPLICATION

Bench cutter D 100 has been designed, manufactured and assembled to cut every kind of fabrics or materials, with the exception of metal, plastic or wood, by means of rotary circular, decagonal or heptagonal blades.

This equipment must not work:

- in areas prone to explosions;
- in presence of fine dust or corrosive gases;
- on wet or damp materials;
- to cut plastic, metal and wooden materials.

It is forbidden to use bench cutter D 100 for purposes different from the above-mentioned ones.

## 8. USE WARNINGS

We recommend following the indications below in order to always work in safety conditions.

- All the operations must be carried out complying strictly with the safety rules of the country where the device is to be installed.
- It is **STRICTLY FORBIDDEN** to smoke during the installation or adjustment operations of the bench cutter.
- The Customer undertakes to comply with and make his staff observe all the rules and regulations in force concerning safety, prevention of accidents and health in the work place. Therefore, the Customer assumes the responsibility to strictly follow all the rules and regulations in force, as well as the special provisions in force in sport and public installations the Customer declares to know after receiving all the relative necessary information.
- The bench cutter works also without their safety protective device. This protective device must **NEVER** be removed.
- Always check the resistance of the material to be cut and the kind of blade which is being used.
- The Customer shall equip his own personnel with all the individual safety protections for the execution of the works, as well as with the ones which might be prescribed by the Manufacturer due to specific danger conditions of the plant or of the area where the personnel must work.
- Only one operator must use the bench cutter always standing behind the guide handle. Do not make any adjustment while the blade is working or while the electric plug is connected.
- Always pay attention to the electric cable position to prevent it from being cut or damaged by the blade.
- It is allowed to assemble bench cutter D 100 on machines O.E.M. on condition that their original structure is not modified. Otherwise, the intervention must be certified by Rasor®.

## 9. ELECTRIC CONNECTION

Firstly make sure that the lines are able to feed the cutter correctly, in compliance with the safety rules (for the feature required see par. 5).

### **WARNING**

We suggest installing a magnetothermic safety device before the cutter and check that the ground circuit is effective. Before working on the feeding cable pull the plug out. Check that electric connections and protections correspond to the driving force and the plate data values (voltage and current), required by the different electric circuits. Possible faulty ground connections make the working conditions unsafe. Possible damages are not charged to Rasor®. By referring to the EC 11-27/1 standard all the works carrying out by means of electric current must be performed by a staff, who has been provided with all the devices required by the above-mentioned standard. For the works carried out under voltage, it is necessary that the employer certifies the suitability, against formative processes. As the cutter D 100 is supplied without plug, the user must use a plug homologated in the country in which the cutter is used. In the European Countries a Shuko plug is required (see picture 3). The electric cable is equipped with yellow and green grounding. Never change the length of the cable supplied.

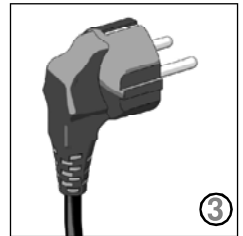



## 10. RESIDUAL RISKS

Even though the bench cutter is safe, operators must pay attention to preserve their and other people's safety.

- ⊗ At the end of the working operations, the motor could be very hot.
- ⊗ The cutting blade can work even when the protective device is disassembled.

## 11. USE

To use the bench cutter manually, proceed as follows:

- 1) Lay the material to be cut on a table;
- 2) Connect the cutter to the electric feeding (see picture 4);
- 3) Put the material on the cutting foot;
- 4) Adjust the front mobile protection according to the thickness of the material to be cut;
- 5) Enable the switch; once it has been enabled, it lights with a green light (see picture 5);
- 6) Press the starting lever after having moved the safety catch (see picture 6);
- 7) Push the bench cutter to the desired direction, by trying to put the material in front of itself as stretched as possible, preventing it from curling in the front part of the cutter. To work, the cutter must be placed on a surface and must slide by means of the rolls placed under the sliding platform.

### NOTE:

The thrust on the bench cutter must be as uniform as possible. To carry out linear cuts with precision (and to follow predetermined paths), we also recommend using the arrow point (see point "A" in picture 7).

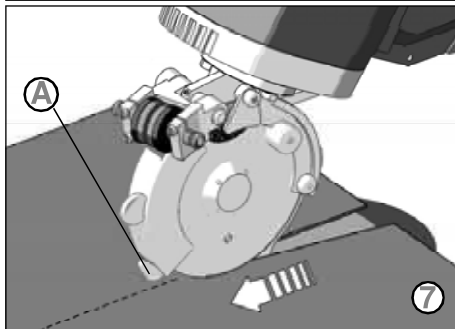
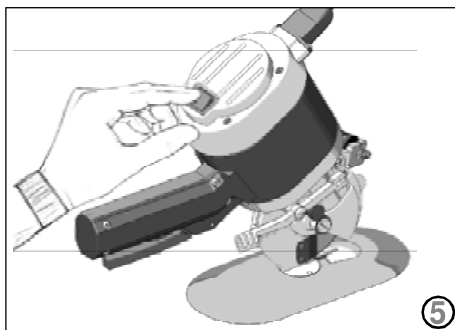
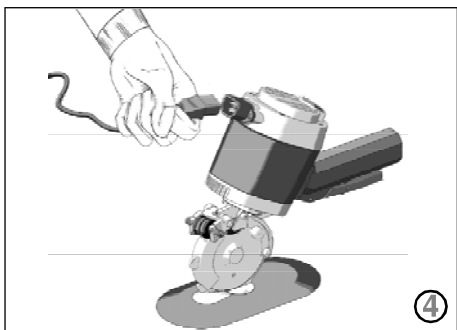

## 12. BLADE SHARPENING AND SHARPENER ADJUSTMENT

The blade sharpening is carried out with the cutter on, by lowering the proper lever (1, Pict. 8), until the cutting edge of the rotating blade is reached and the external edge is sharpened.

To carry out a good sharpening, lower the lever progressively (1, Pict. 8), by avoiding abrupt movements and an extreme pressure on the lever itself, in order to protect the emery wheel from wear or damage. The sharpening procedure must be carried out carefully in particular when a worn blade is replaced with a new one. In this case, an extreme pressure on the sharpening lever may damage the cutting profile of the new blade, compromising its correct use. Therefore, we suggest adjusting the emery wheel as follows, after assembling a new blade on the cutter.

- Disconnect the device from the power supply.
- Loosen the three sharpener screws (2, Pict. 9), but do not remove them.
- Manually lower the sharpener so that the emeries come into contact with the cutting blade profile, as shown in picture 10; the wheels must not penetrate into the blade more than 2 mm (Pict. 10).
- Manually rotate the threaded bushes (3, Pict. 9) by bringing closer the two emeries and keeping a distance between them of 1-1.2 mm.
- Tighten the screws (2, Pict. 9) and sharpen the blade according to the modes previously described.

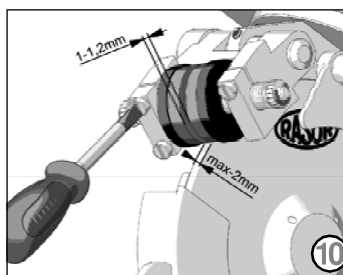
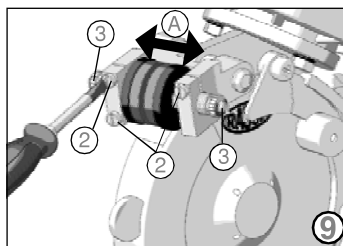
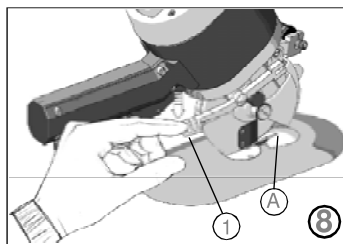

**NOTE:** during this operation check that the emery wheels start rotating simultaneously, bringing near or moving away one of the two wheels to get a simultaneous movement of them.

## 13. SLIDING FOOT ADJUSTMENT

After many sharpening operations, the blade diameter diminishes progressively: in this case, the foot (A, Pict. 8) must be brought again near the blade cutting profile. To carry out this operation do as follows:

- Disconnect the device from the power supply.
- Overturn the cutter by putting the motor on the working surface.
- Loosen the screw (B, Pict.11) and let the foot slide along the proper groove, putting it near the blade until it comes close to it.
- Tighten again the screw by keeping the foot in this position (B, Pict.11).

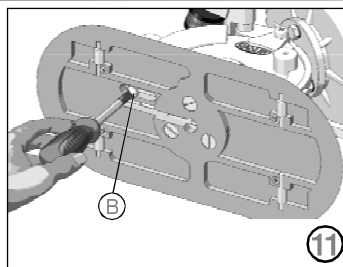

## 14. LUBRICATION

Every 3-4 working hours, it is necessary to lubricate the pair of gears. To carry out this operation, remove the protective plug "A" located on the motor support of the bench cutter and fill it with lubricating grease Rasor. Screw plug "A" again few turns. Screw plug "A" a few turns every 2-3 working hours (see picture 12).

### WARNING

The blade must never be dirty with grease or oil.

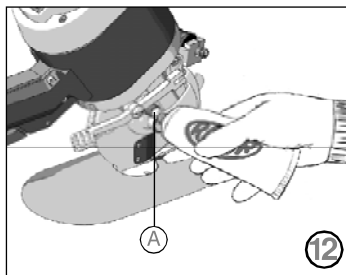

## 15. BLADE REPLACEMENT

If the blade is no more able to cut (even after repeating the sharpening operation several times) it is necessary to replace it. To carry out this operation, use butterfly wrench "1" and drift "3" locking the blade (shown in picture 13).

To replace the blade, proceed as follows:

- 1) Use some protective gloves in compliance with Legislative Decree 242 dated 19 March 1996 (use of personal protection devices);
- 2) Remove the fixed rear safety protection "A" (see picture 14) by unscrewing the cross-slotted screw "C" and the cross-slotted screw "D" by means of the proper screwdriver (not supplied by the manufacturer) and by extracting washer "E" as shown in picture 15. Remove the mobile front safety protection "B" (see picture 14) by unscrewing pin "F" and by extracting washer "G" as shown in picture 15.
- 3) Insert drift "3" (see picture 13) into hole "H", so as to lock the blade (the hole on the blade must correspond to the one on the structure).
- 4) Use butterfly wrench "1" to unscrew nut "L" and remove blade "M" (see picture 16).
- 5) Replace the worn blade with the new one "2", being careful to center the blade on the shaft, in the correct position, and remember to assemble it with the side with the writing Rasor positioned towards the external side of the bench cutter.
- 6) Assemble all the components again and carry out the sharpening.

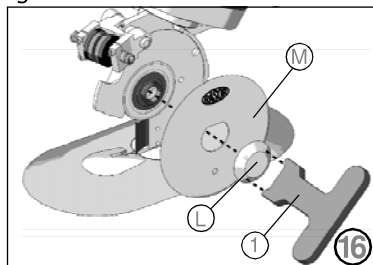
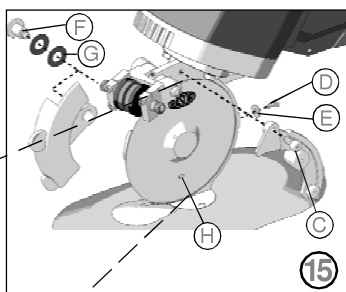
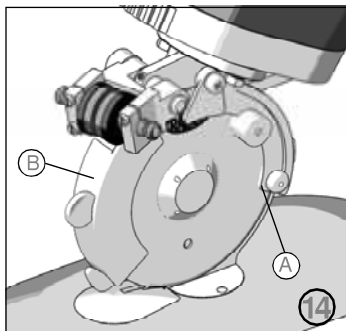
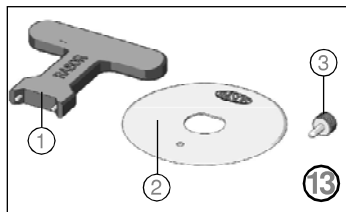

## 16. TROUBLESHOOTING

✕ PROBLEM	⇒ SOLUTION
The fabric is not cut or it gets stuck between the blade and the sliding foot	Check the distance between the blade and the foot
	Check the kind of fabric
	Sharpen the blade
	Check the fabric thickness
	Check the compatibility between blade and fabric
	Make sure that the motor turns correctly
The cutter is noisy	Reduce the feeding speed
	Carry out the lubrication
	Disassemble the blade and remove the material residues
The cutter starts slowly, workd intermittently or it does not start	Check the wear of the pair of gear
	Check the motor brushes
	Replace the protection fuse
The cutter does not start	Check the feeding cable
	Open the cutter handle and replace the fuse integrated in the circuit (see the exploded view in the following page)

## 17. SPARE PARTS / EXPLODED VIEW

CODE	DESCRIPTION	CODE	DESCRIPTION	CODE	DESCRIPTION	CODE	DESCRIPTION
10CEXTG	CIRCULAR BLADE Ø 100 mm, EXTRA STEEL	T 102100	LOWER CAP FIXING SCREW	T 103400	SHARPENER SPRING	T 105100	SHARPENER PIN FIXING SCREW
T 100102	MOTOR COVER WITH GROOVE	T 102200L	MOTOR CASE WITH MAGNETS	T 103500	SHARPENER UNIT	T 105200	MOTOR SUPPORT FIXING BOLT
T 100200	MOTRO COVER FIXING SCREW	T 102201	PERMANENT MAGNET PAIR	T 1035FCPL	FINE-GRAINED COMPLETE SHARPENER (RED)	T 105300	WASHER
T 100201	VOLTAGE PLUG FIXING SCREW	T 102300L	HANDLE SECTOR, 1999 SERIES	T 1035GCPL	COARSE-GRAINED COMPLETE SHARPENER (BROWN)	T 105400	ANTI-FRICTION BUSH
T 100300	ADJUSTMENT LOCKING SCREW	T 102400	HANDLE SECTOR FIXING SCREW	T 1035MCPL	MEDIUM-GRAINED COMPLETE SHARPENER (BLUE)	T 1055CPL	COMPLETE MOTOR SUPPORT
T 100400	MOTOR BEARING ADJUSTMENT	T 102701	3 POLES PLUG WITH FROMMET	T 103600	EMERY UNIT FIXING SCREW	T 105600	SHIM ADJUSTMENT WASHER
T 100500	THRUST WAVY RING	T 102702	SOCKET - 3 POLES	T 1038FCPL	FINE-GRAINED EMERY UNIT (RED)	T 105700	GEAR RING BEARING FIXING RING NUT
T 100600	CARBON BRUSH WITH ELECTRICAL CONTACT	T 1027CPL	FEEDING CABLE WITHOUT PLUG	T 1038GCPL	COARSE-GRAINED EMERY UNIT (BROWN)	T 105800	GEAR RING BEARING
T 100700	CARBON BRUSH HOLDER	T 102900	HANDLE SWITCH WITH LIGHT	T 1038MCPL	MEDIUM-GRAINED EMERY UNIT (BLUE)	T 1059CPL	COMPLETE GEAR RING
T 100800	CARBON BRUSH HOLDER CLIP	T 102901F	FEEDING ELECTRONIC CIRCUIT (WITH FUSE)	T 103900	THREADED BUSH	T 106000	GEAR RING LEFT FIXING SCREW
T 100900	CARBON BRUSH HOLDER FIXING SCREW	T 102902	HANDLE PUSH BUTTTON	T 103901	SHIM ADJUSTMENT WASHER OF THE BUSH	T 106100	SUBBLADE RING
T 101000	MOTOR BEARING Ø 7 mm	T 102903	HANDLE LEVER PUSH BUTTTON	T 104000	SEEGER RING	T 106300	RING NUT FIXING THE BLADE
T 101200	ANTI-GREASE WASHER	T 102904	COVER SWITCH WITHOUT LIGHT	T 104100	BACK PROTECTION GUARD	T 106400	PLATFORM PIN
T 101300	COMPLETE ROTOR 220 V	T 102904L	COVER SWITCH WITH LIGHT, SERIES 2008	T 1041CPL	BACK PROTECTION SET	T 1064CPL	SLIDING PLATFORM SET
T 101301	COMPLETE ROTOR 110 V	T 102906	RATCHET AND LEVER FIXING PIN	T 104200	SCREW 2,6MA BACK GUARD FIXING	T 106500	PLATFORM ROLLER
T 101302	COMPLETE ROTOR 48 V	T 102908	STARTING LEVER	T 104201	WASHER	T 106800	PLATOFORM ROLLER FIXING SCREW
T 101500	FAN	T 102908CPL	COMPLETE STARTING LEVER	T 104300	SCREW 4MA BACK GUARD FIXING	T 106900	PLATFORM SECTOR
T 101600	MOTOR BEARING Ø 10 mm	T 102909	RATCHET FOR LEVER	T 104401	FRONT PROTECTION CARTER	T 107000	PLATFORM FIXING SCREW
T 101700	COMPENSATION RING	T 102910	RATCHET SPRING	T 1044CPL	FRONT PROTECTION SET	T 107100	SLIDING FOOT
T 101800	WORM SCREW - 4P, M 0,8	T 1029F10	FUSE 2A	T 104500	FRONT PROTECTION FIXING SCREW	T 107200	WASHER
T 101801	ELASTIC PIN	T 103000	HANDLE PUSH BUTTTON/SWITCH FIXING SCREW	T 104501	COUPLE OF CONVEXED WASHERS	T 107300	SLIDING FOOT FIXING SCREW
T 1018CPL	COMPLETE PAIR OF GEAR	T 103100	SHARPENER LEVER	T 104700	GREASER CAP	T 107400	SIMPLE PLATFORM
T 101900	LOWER MOTOR CAP	T 103200	SHARPENER LEVER FIXING SCREW	T 104800	OLLER	T 1074CPL	COMPLETE PLATFORM
T 102000	UPPER MOTOR CAP	T 103201	SHARPENER COLUMN	T 104900	SPRING LOCKING THE THREAD	T 107500	BLADE ASSEMBLING/DISASSEMBLING KEY
T 102001	UPPER CAP FIXING SCREW	T 103300	SHARPENER PIN	T 105000	SCREW 2,6MA SPRING LOCKING THE THREAD FIXING	T 107600	DRIFT LOCKING THE BLADE
						T 107900	LUBRICATING GREASE





---

## WARRANTY

Rasor® Elettromeccanica S.r.l. bench cutter has a 12 month warranty from the date indicated on the last page of this manual, except in case of different written agreements.

The warranty covers all manufacturing and material defects. Replacement and repair operations are covered only if carried out by our company and at our workshop.

The material to be repaired must be sent CARRIAGE FREE.

Once the machine has been repaired, it will be sent CARRIAGE FORWARD to the customer.

The warranty covers neither technicians' intervention on site nor the machine disassembly from the installation place.

If for practical reasons, one of our technicians is sent to the premises, the customer will be charged the costs plus the travelling expenses.

The warranty does not include:

- ☞ failure caused by wrong use or assembly,
- ☞ failure caused by external agents,
- ☞ failure caused by lack of maintenance or negligence;
- ☞ blades and parts subject to wear.

### WARRANTY FORFEITURE:

- ☞ In case of arrearage or other breaches of contract,
- ☞ Whenever changes or repairs are carried out on our cutters without our prior authorization,
- ☞ Whenever the serial number is tampered with or cancelled,
- ☞ Whenever the damage is caused by improper use, bad treatment, bumps, falls and other causes not due to normal working conditions,
- ☞ Whenever the unit seems tampered with, dismantled or previously repaired by unauthorized staff,
- ☞ In case the bench cutters are used for purposes that are different from the ones described in this manual.

All repair operations carried out under warranty do not interrupt its duration.

**All disputes will be settled in the court of justice of Milan (Italy).**

We thank you in advance for the attention you will pay to this manual and we invite you to inform us of any change you deem necessary to improve it and make it more complete.

---

**RASOR ELETTROMECCANICA SRL**

Via Vincenzo Caldesi 6

20161 Milan · Italy

ph. +39 02 66 22 12 31

fax +39 02 66 22 12 93

info@rasor-cutters.com

[www.rasor-cutters.com](http://www.rasor-cutters.com)

**FOLLOW US:**

