

Preface and General Safety Notes

Part 1: Operating Instructions Cl. 271 to 274

1. Product Description	
1.1 Short Description and Proper Use	5
1.2 Technical Data	6
1.3 Optional Equipment	7
2. Machine Elements and their Functions	
2.1 Elements on the Machine Head	8
2.2 Elements on the Frame	12
3. Operating	
3.1 Needles, Threads and Thread Tension	14
3.2 Spooling the Bobbin Thread	14
3.3 Replacing the Bobbin and Setting the Looper Thread Tension	15
3.4 Threading the Needle Thread	16
3.5 Regulating the Needle Thread Tension	17
3.6 Thread Regulator	17
4. Maintenance	
4.1 Cleaning and Checking	18
4.2 Lubrication	20

Following Patents and Registered Utility Models apply:

Status March 1994

DE - 41 15 520

DE - 87 05 550

DE - 41 05 563

JP - 1 933 346

JP - HEI - 4 - 32044

DE - 41 38 402

DE - 40 04 892

JP - HEI - 4 - 312432



1. Product Description

1.1 Short Description and Proper Use

The 271 to 274 are flat single needle-double saddle stitch sewing machines with thread trimming devices for straight seams to stitch type 301.

Properly employed the machine may only be used for sewing materials of textile fibre and garment leather.

271 with skipping bottom feed.

The machine has an automatic central oil wick lubrication with oil reservoir as well as a separate automatic hook lubrication, also with oil reservoir. The oil levels are visible through inspection glasses.

Through equipping with thread regulators the same sub-classes, with appropriate choice of sewing device and needle, can be used for sewing thick as well as thin material.

The operation of the tension activation, the thread trimming, the automatic bartack and the pressure foot lift occur electro-magnetically. No compressed air is required with the exception of classes 273, 274 and 272-740142.

For further technical characteristics and equipment for each sub-class see under 1.2 Technical Data.

272 as 271, but with additional needle transport.

273 as 271, but with additional intermittent roller top feed.

The transport distance of the roller top feed is a max. 7mm. With an adjustment wheel at the front of the machine arm it can be given a setting differing from the bottom feed.

It has stable rpm up to a maximum number of stitches of 5500 stitches/min. This means constant stitch lengths as well as smooth and unshifted seams even with quick rpm changes.

Automatic lifting of the carrier roller by change over to transport to the rear(bartack).

274 as 273, but with additional needle transport.



1.2 Technische Data

Sub-classes	Stitches/min		1	2	3	4	5	6	7
	max.	from factory							
271-140041	5500	4800	4mm	x					
271-140042	5500	4800	4mm	x	x	x			
271-240042	5500	4800	4mm	x	x	x			x
272-140041	5000	4800	4mm	x					
272-140042	5000	4800	4mm	x	x	x			
272-160062*	5000	4000	6mm	x	x	x			
272-640141	5000	4800	4mm	x			x		
272-640142	5000	4800	4mm	x	x	x	x		
272-740142	5000	4800	4mm	x	x	x		x	
273-140042	5500	4800	4mm	x	x	x			
274-140042	5000	4800	4mm	x	x	x			

* Extra-large shuttle = 70% greater capacity of the underthread spool than with the standard hook

To 1: Max. stitch length for each sub-class

To 2: Thread trimming for needle and bobbin thread

To 3: Electro-magnetic automatic bartack. It is switched via the pedal and executes the following functions: lowering the pressure foot, seam beginning and seam end bartack, needle and bobbin thread trimming, raising the pressure foot.

To 4: Keys on the arm head:

- Needle high - low
- Bartack on - Bartack function switched off at the control panel
- Bartack suppressed - Bartack function switched on at the control panel
- Bartack within the seam

To 5: Edge cutter right, next to the needle. Switched on and off with the hHand lever or, as optional equipment, electro-pneumatically via key. Depending on the sewing unit (E-no.), the cutting interval is 3.5 ; 5.0 ; 8.0 or 10mm. Special sewing devices are required for graduated cutting. The knife stroke is 5.5mm.

To 6: Edge cutter, but with separate electric drive. Two cutting rpms can be switched in.

To 7: Edge cutter, which cuts into the material edge crosswise during sewing, e.g. for tension-free turning over of round neck openings, collars, arm holes, etc. The cut occurs after every 6 stitches. On request after 4 stitches. The cut depth has a max. of 15mm. It is adjustable up to about 1mm to the seam.

Needle system: 134, 797 or Sy 1955-01

clearance under the pressure foot

When raised: 8.0mm by 271 and 273
9.5mm by 272 and 274

When sewing: 8.0mm

Operating pressure: 6 bar

Air consumption: 0.02 NI per work cycle by 273 and 274
0.1 NI per work cycle by 272-740142



Noise Level Lc: Work station specific emission value to DIN 45635-48-A-1-KL2 by stitch length 3.2mm
271-140041 and 140042 with stitches 4800/min. = 80 dB(A)
272-140041 and 140042 with stitches 4800/min. = 82dB(A)
272-140041 and 140042 with stitches 4500/min. = 80dB(A)

1.3 Optional Equipment

App. 301	Covering hood for the machine head
Z 120 1801	Electro-magnetic thread wiper for 271 and 272 sub-classes -140000 and -160000
Z 120 1851	Electro-magnetic thread wiper for 273 and 274
Z 133 371	Reflected light barrier for automatic sewing stop at the material end with follow-up functions. For motors with external control panel V730 or DB5.
Z 116 6741	Electro-pneumatic device for alternating sewing with two differently set stitch lengths and two differently set needle thread tensions. Normal seam and seam with thread drawing (basting stitches). Partial strengthened tension (Seam thickening) and ornamental seams.
Z 124 401	Electro-pneumatic operation for on/off switching of the edge cutters via key for 272-640142.
Z 145 1	Graduated edge cutting (finger version for lightest materials). In conjunction with the sewing unit 272/E 111 for widths of cut of 4.5 and 7mm. ■
Z 145-101	Graduated edge cutting (2 knife version for medium heavy material). In conjunction with sewing unit 272/É 112 for widths of cut of 3.5 and 6,5mm.
722 2041	Container for cutting waste for connection to the in-house vacuum system. If this is not available then the appropriate centrifugal blower is to be used.
999 260029	for 3-phase current 380-400V+N, 50Hz
999 260030	for 3-phase current 220-230V, 60Hz
999 260031	for 3-phase current 415-440V, 50Hz
933 5736	Toothed steel roller, 9mm wide for 273 and 274 roller transport
273 1041 u. 274 1141	Height setting for the pressure foot with hard to transport material, e.g. velvet.
570 1833	Filter regulator for the compressed air connection
271 661	Parts set, knee lever for pressure foot lift by machines with automatic bartacker.
271 1671	Parts set, hand lever for seam bartacking for machines with automatic bartacker.



2. Machine Elements and their Functions

2.1 Elements on the Machine Head

Element	Function
1Screw	– Regulating of the pressure foot pressure. The Setting of the screw is to be fixed.
2Hand lever	– Turning the edge cutter 10 on and off. The position of the hand lever is variably adjustable.
3Spooling device	– See under Section 3.2 Spooling of the Bobbin Thread.
4Control panel	– See the motor manufacturer's instructions.
5Oil reservoir	– The oil level should not be allowed to drop below "MIN". When necessary fill with ESSO SP-NK10 oil to "MAX".
6Adjustment wheel	– Setting the stitch length for reverse sewing (with sub-classes -....41 via hand lever).
7Adjustment wheel	– Setting the stitch length for forwardsewing (with sub-classes -....41 via hand lever).
8Rest	– For tilting the machine head to the back (not on classes 273 and 274).
9Needle thread tension	– Turn in direction + = higher needle thread tension Turn in direction - = looser needle thread tension
10Edge cutter	– Function see following page.
11Needle	– System 134, 797 or Sy 1955-01



- Risk of Injury! -

Before replacing the needle it is essential to turn the main switch off.

12Locking button	– Lock the pressure foot in the raised position
13Hand lever	– Setting the carrier roller up. It is swung out of the work area. Sewing only with bottom feed
14Adjustment wheel	– Transport length for the top feed roller
15Roller top feed	– Function see following page



272-640142

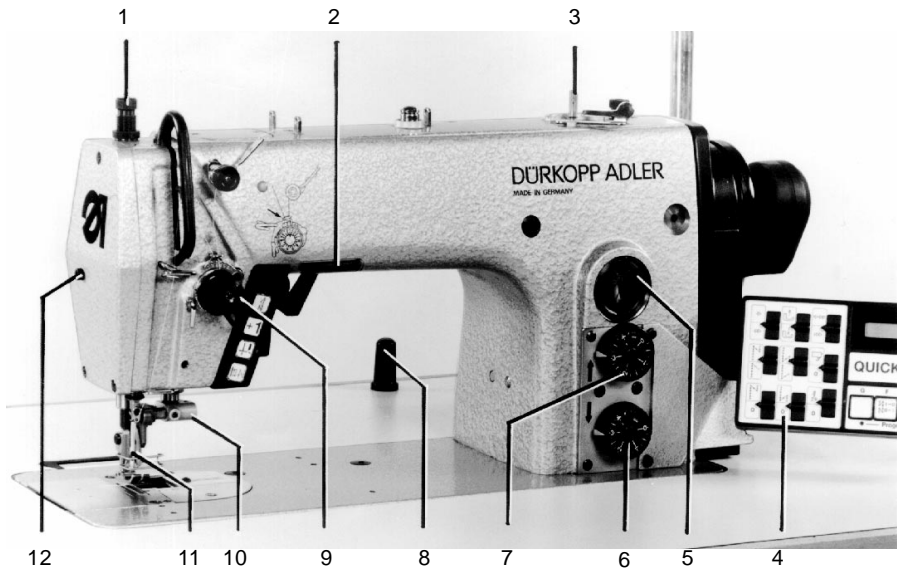

274-140042

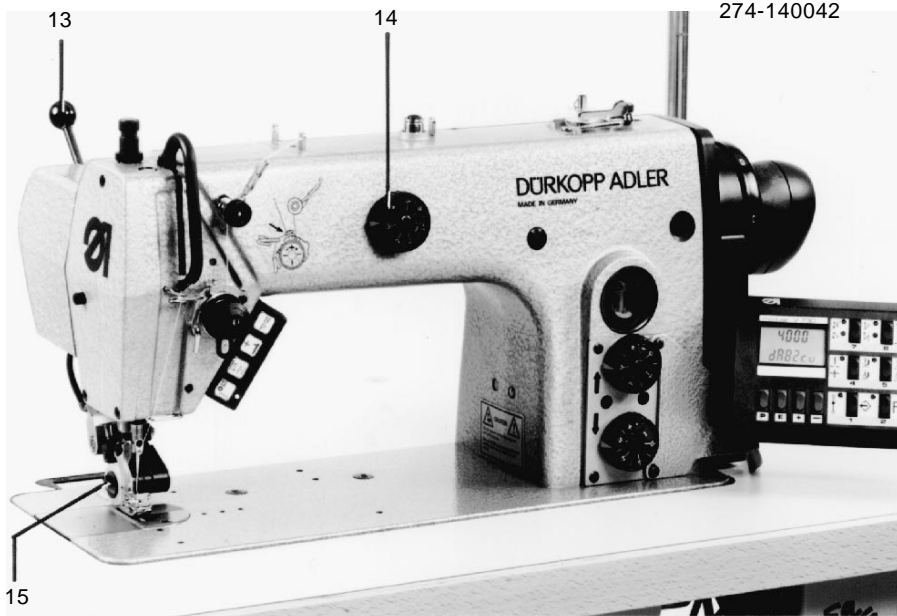



Element	Function
16Separate drive for edge cutter	- Two cutting rpms switchable (only 272-740142)
	- Risk of Injury! - Caution in the area of the edge cutter.
17LED	- The blinking of the diode shows that the edge cutter is operationally ready. To switch on and off the following variants are available: * Manual via key * Via the sewing pedal through the run signal of the sewing drive * Automatic "On" or "Off" after a selected number of stitches * Automatic "Off" after thread trimming (See Installation Instructions Section 13.)
18Switch for edge cutting	- I = Normal rpm D = Drive "Off". Knife outside the sewing area II = Increased rpm for greater stitch lengths and thick materials
19LED	- Indicator for main switch "On" (only 272-740142)
20Key	- Beginning or end bartack on - Bartack off at the control panel Beginning or end bartack off - Bartack on at the control panel
21Key	- Single stitches
22Key	- With sewing machine at rest: Needle up-down. With sewing operation: Bartack (reverse sewing) at desired position in the seam
23Key	- Switching the edge cutter on and off. By sub-class 272-640000 the pneumatic operation Z124-401 (optional equipment) must have been installed. Otherwise the key has no function.
24Key	- Raise and lower the top feed roller manually. Automatic lowering after a number of stitches see Installation Instructions Section 12.
25Knee lever (only sub-classes -....41)	- Before tilting the machine head to the back turn the main switch off and remove the knee lever. To slip it out conduct movements 1 and 2 and to hang it back in movements 3 and 4.
26Hook lubrication	- The oil reservoir for the hook lubrication should not drop below the "Min" mark. By normal operation the oil level should be checked weekly. Through the fill opening fill Esso SP-NK 10 oil up to the "Max" mark. The oil flow for the hook lubrication can be regulated at screw 5.



272-740142

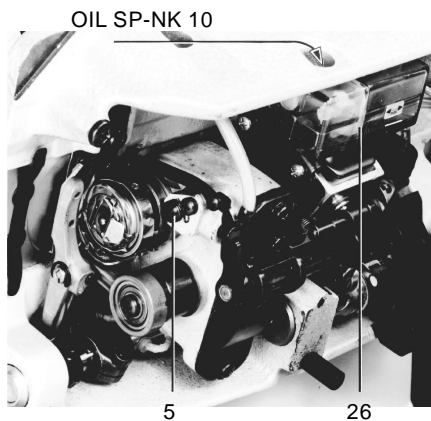
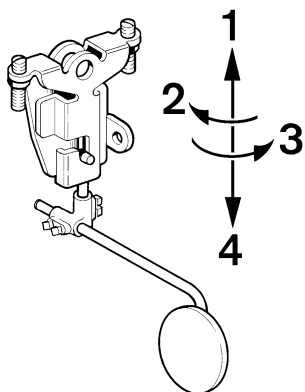
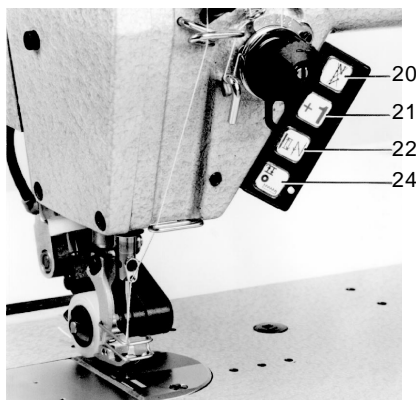
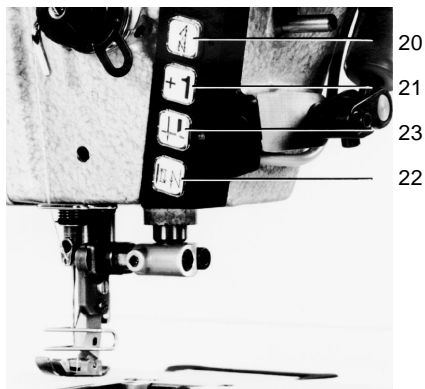
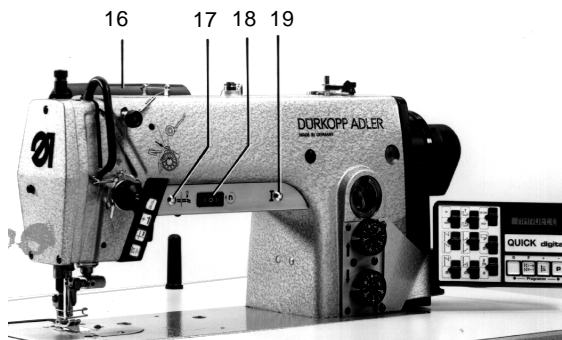



2.2. Elements on the Frame

Elements

1 Main Switch

Function

- Turn the sewing drive on and off.
The sewing machine head is operational.



Attention!

For threading, replacement of sewing tools (such as needle, pressure foot, needle plate, material feed etc.), cleaning, when leaving the work place as well as during maintenance work it is essential to turn the main switch off.

See also General Safety Notes.

2 Pedal

- **A** Rest position. No function.
B Raise pressure foot during machine rest
C Sewing to a maximum number of stitches by appropriate step down.
D Seam bartacking* - Thread cutting - Raise pressure foot*
*Not with sub-classes -....41

Maintenance unit

6 Air filter and

7 Water separator

4 Pressure regulator

- Before the water level reaches the air filter 6 screw in screw 8 and release the water under pressure.
- For setting the air pressure at 6 bar pull up and adjust the knob 4.
Turn to the right = Pressure increase
Turn to the left = Pressure decrease

9 Oil Mister

- The oil mister provides the solenoid valves and cylinders with lubricating oil .
With the regulating screw 11 set at approx. 1 drop of oil for 15 work cycles.
To fill the mister 9 turn off the compressed air. Do this by pulling up the knob 4 and turning to the left.
Screw out screw 10 and fill Esso SP - NK 10 oil up to the grooved marking of the oil reservoir.

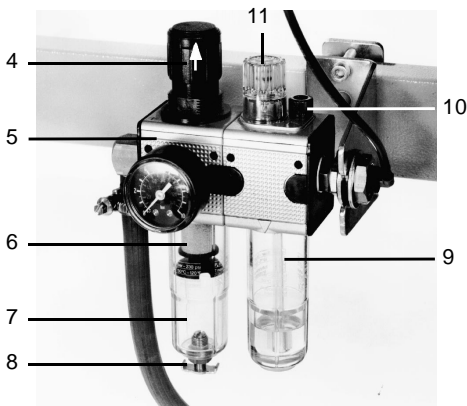
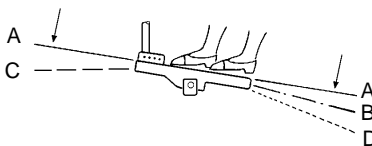
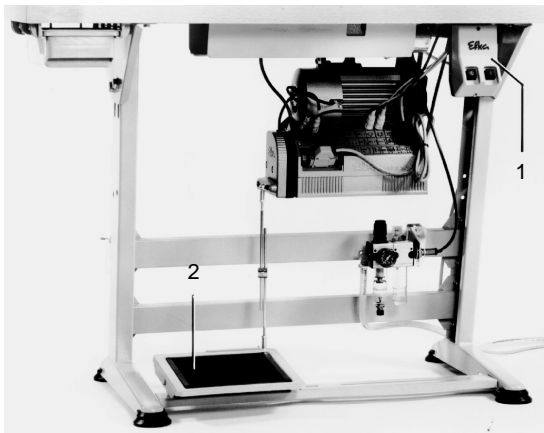



3. Operation

3.1 Needles, Threads and Thread Tension



Needles of the systems 134, 797 or Sy 1955-01 are to be used.

When inserting the needle care is to be taken that it is pushed in until contact is made and that the furrow of the needle is turned to the right, e.g. to the hook tip.

The following table shows for each needle thickness the recommended thread thickness, thread tension and t thread regulator setting.

Needle Thickness	Thread	Needle Thread Tension1)	Looper Thread Tension. 1)		Thread Regulator 1)	
			Cl.271/273	Cl.272/274	Sm. Hook	Extra-large Hook
70	Poly-Poly Nm 95/2	60-100	20-30	25-35	4	2.5
80	Poly-CO Nm 80/2	60-100	20-30	25-35	3.5	2
90	Poly-Poly Nm 80/2	60-100	20-30	25-35	3.5	2
100	Poly-Poly Nm 65/2 CO Ne 50/2	70-100	20-30	25-40	3	2
		60-100				
110	Poly-CO Nm 50/2	100-150	25-35	30-45	3	2
120	Poly-Poly Nm 30/3 Poly-CO Nm 25/2	200-300	30-40	40-70	2.5	1.5

1) Transport length 2.5 mm and number of stitches 5000/min f. sub-cl. -140041,-140042,-640041,-640142 and-740142

1) Transport length 4 mm and number of stitches 4000/min f. sub-cl. -160062

3.2 Spooling of the Bobbin Thread

Spooling occurs automatically with pressed on bobbin winder flap 1 during sewing.

See the following illustration for threading the bobbin thread from the thread stand to the bobbin winder.

Remove the thread rests to be found on the bobbin hub before spooling.

Pre-wind the bobbin thread to the right around the bobbin hub.

Cut off the thread end in the cutting clamp 2.

The filled bobbin is removed in the same way.

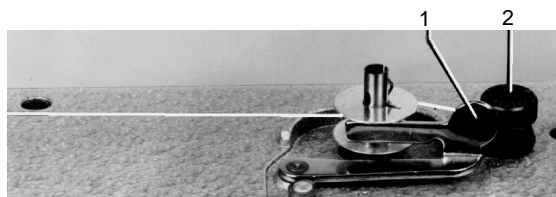



3.3 Replacing the Bobbin and Setting the Loper Thread Tension



- Risk of Injury -

Turn the main switch off!

Removing the Bobbin

Lift up lid 3 and remove the upper part of the bobbin case with the bobbin.

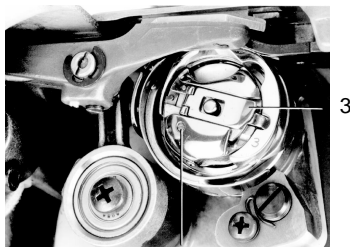

Inserting the Bobbin

The insertion of a new, filled bobbin can be seen in the following illustration.

The thread is pulled in the slit a under the leaf spring b up to the hole c. When the thread is pulled off the bobbin must turn in the direction of the arrow.

Important Note!

In order that the bobbin brake spring 5 can move freely the area behind it is to be cleaned **at regular work intervals** of sewing dust. Raise the spring, e.g. with a needle, and blow out.

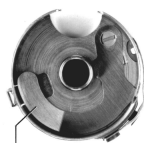

5



6

7

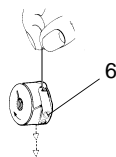

6

Setting the Loper Thread Tension

With a recommended looper thread tension of e.g. 30g, 15g should be achieved through the brake spring 5 and 15g through the tension spring 7.

As the base position of the tension spring 7 the following applies:

Allow the bobbin case to slowly lower through its own weight. See sketch.

The brake spring 5 blocks the run-on of the bobbin during thread trimming.

Set its braking effect sensitively.



To set the two tension values proceed as follows:

- Turn the regulating screw 6 so far back that the tension of the leaf spring 7 is completely released.
- Set the brake spring 5 accordingly by turning the screw 4.
- Insert the bobbin into the upper part of the bobbin case and thread the looper thread as per the illustration.
- Insert the bobbin case with bobbin into the hook.
- With a so-called air stitch pull the looper thread to the top of the stitch hole with the aid of the needle thread.
- Pull off the looper thread at an angle of 45°. About half of the tension value should be felt. Then tighten the regulating screw 6 to the recommended tension.

3.4 Threading the Needle Thread



- Risk of Injury -
Turn the main switch off!

The thread path of the needle thread is shown in the following illustrations.

For a, as far as possible, tension-free unwinding of the threads from the thread stand thread through only one thread hole of the unwinding arm.

The other thread holes are closed with the plugs found in the accessories package.

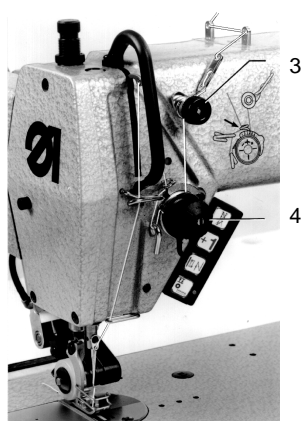
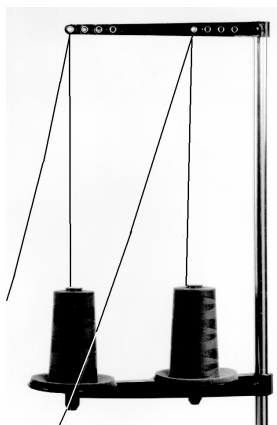



3.5 Regulating the Needle Thread Tension

Pre-tensioning for Thread Trimming

For the sure functioning of the thread trimming with opened main tension 4 a small residual tension of the needle thread is required.

This residual tension is achieved by pre-tensioning 3. At the same time it influences the length of the cut needle thread end. (Starting thread for the next seam.)

Short starting thread = tighten the knurled nut 3.

As base position applies:

Front of the knurled nut and bolt flush.

Greater adjustments of the pre-tensioning makes a readjustment of the main tension necessary.

Main tension

Pre-tensioning 3 and main tension 4 should give the recommended needle thread tension of e.g. 80g.

Set the main tension 4 accordingly.

3.6 Thread Regulator

With the thread regulator 6 the needle thread quantity required for stitch building can be regulated. The setting is dependent on stitch length, material thickness and thread characteristics. ■

Note:

Only a precisely set thread regulator assures an optimal sewing result.

The needle thread loop should glide over the hook without excess and with little tension.

Loosen screw 9 and set the regulator accordingly.

The vertical wire 7 serves as a setting aid in conjunction with the scale 8.

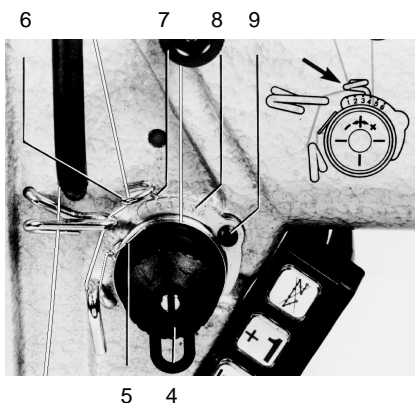



Note

With a correct regulator setting the thread controller spring 5 will be pulled approx. 0.5 mm down out of its upper end position when the thread loop passes the maximum hook girth, that is, when the greatest amount of thread is required. See illustration.

The dimension 0.5 mm is a guideline. It can be greater or smaller depending on the thread controller spring tension.



4. Maintenance



- Risk of Injury -

During cleaning and lubrication of the machine it is essential to turn the main switch off.

The maintenance work must be conducted at the latest after the number of operating hours shown in brackets ().

Other maintenance intervals may result when working special materials.

4.1 Cleaning and Checking

A machine kept clean protects against malfunctions!

- Remove sewing dust from under the needle plate. (8 hours)
This is best done with a compressed air pistol.
- Remove the sewing dust collecting between the transporter web. (8 hours)
Remove the needle plate for this.
- Clean the area below the bobbin brake spring 3 of sewing dust. (8 hours)
Slightly raise the spring 3 e.g. with a needle leicht and blow out.
- Clean the sewing dust from the motor ventilation sieve. (8 hours)
- If the machine is equipped with the compressed air maintenance unit 5 check the oil and water levels.



Before the water level rises to the filter insert 6 it is essential that, with the maintenance unit under pressure, the water be blown out of the water separator 7 after screwing in screw 8.

Water level in the water separator 7 (40 hours)

Clean the air filter insert 6 (500 Std).

Check the oil flow of the oil mister 11 (180 hours)
See under Section 2.2

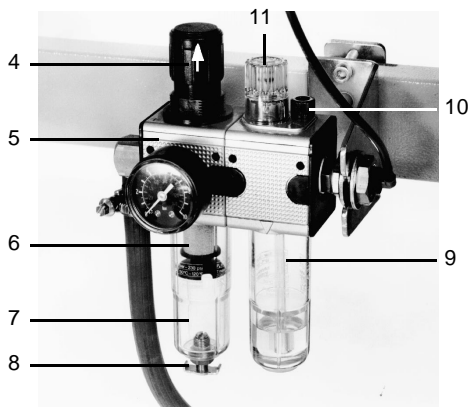
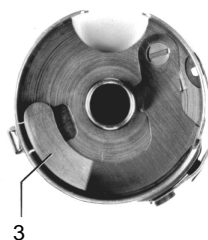



4.2 Lubrication

For the lubrication of this machine it is essential that Esso SP-NK 10 or an absolutely equivalent quality lubricating oil be used.

The maintenance of the parts to be provided with oil is limited to the following:

- The oil level in the oil reservoir 1 may not drop below the "MIN" mark. (40 hours)
With the machine upright fill oil to the "MAX" mark.

With the exception of the hook lubrication all bearing positions on the machine are supplied via a central oil wick lubrication from the oil reservoir 1.

- The oil level in the oil reservoir 2 for the hook lubrication should also not be allowed to drop below the "MIN" mark. (40 hours)
With the machine head tilted back fill oil to the "MAX" mark.
- When necessary fill the oil reservoir 9 of the maintenance unit to the groove marking with oil. (40 hours)

For this completely shut off the compressed air by turning the knob 4 to the left and then screwing out screw 10.

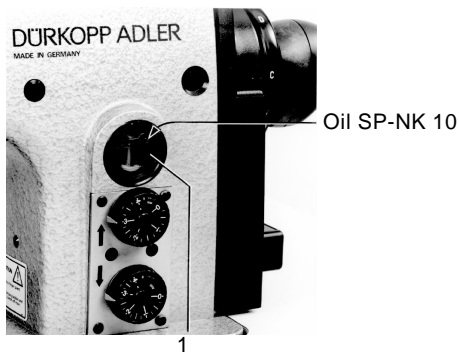

Oil SP-NK 10

